

P10R V2 User manual

Danger and Warning

- DO NOT shine light directly into eyes. This may cause temporary blindness and/or cause permanent damage to the eyes.
DO NOT cover the light head when the flashlight is on or place the light head on the ground. The heat dispersion of the light may cause damage to the flashlight itself or even result in burning other objects.
Keep out of reach of children.
DO NOT activate turbo mode repeatedly under high temperature to prevent the flashlight body from overheating and hurting the user's hand.

Inside the box

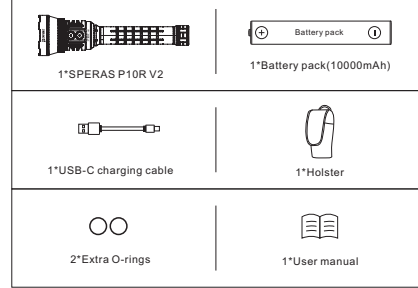

Specification

Table with columns: FL1 STANDARD, Output, Runtime, Beam Intensity, Beam Distance, LED, Lens, Battery Source, Charging Time, Impact Distance, Waterproof, Material, Finish, Dimension, Net Weight. Rows include Turbo, High, Medium, Low, ECO, Strobe, SOS modes.

Product Overview

The SPERAS P10R V2 is a high performance, high lumen LED flashlight with 10000lm max output that utilizes 3pcs imported Luminius SST70 LEDs. The dual rubber buttons design, allows to fast adjust the mode with the bottom button and easily reaching to the turbo mode with the top button.

Battery Installation

Before the first use, please remove the insulating film of battery in the flashlight. And if the battery needs to be changed, make sure the positive polarity side of the battery faces toward the direction of the flashlight head (the side of the LED).

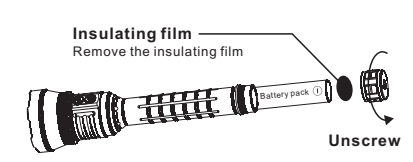

Operating Instructions

- Top button: 1.) Quick double clicks the top button to activate the strobe mode, and quick double clicks again will enter the SOS mode. Single click will return to the state before the Strobe.
2.) At any state (except the strobe and SOS mode), long press the top button for 0.3s to enter the turbo mode. Release the button to revert back the previous state.
Bottom button: 1.) ON/OFF: In the OFF state, click the bottom button to enter the memory mode, long press the bottom button for 0.3s to turn off the flashlight.
2.) Change brightness mode: In ON state, click the bottom button to change the mode instantly. The mode will circle from Eco, Low, Medium, High, Turbo with clicks.
3.) ECO mode: In OFF state, long press for 0.3s the bottom switch to instantly activate the ECO mode.
Lock/unlock: 1.) Lock: In any state, long press both buttons for 2s at the same time, the flashlight will blink twice and then enter the lock state. Once locked, press any button, the orange LED indication will blink 2s.
2.) Unlock: Quickly click 3 times (any button), the flashlight will blink twice to show you that the flashlight is in the unlock state.

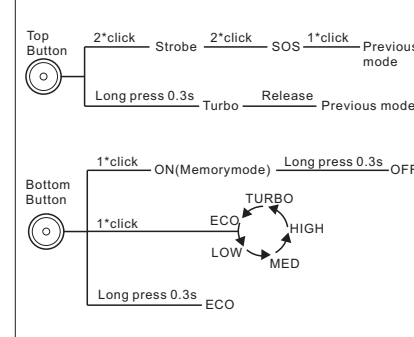

Charging

The P10R V2 supports 5V/3A and 5V/2A charging with compatible power adapter. Insert the cable to the type-C port and then connect the adapter to charge. When charging, the indicators on the buttons will display as follow: Green: full charged; Red: Busy charging; Orange: Check that the battery is correctly seated or faulty battery. Note: We kindly suggest that only the included battery pack (7.4V/5000mAh) to be used for charging. Do not use flashlight when charging.

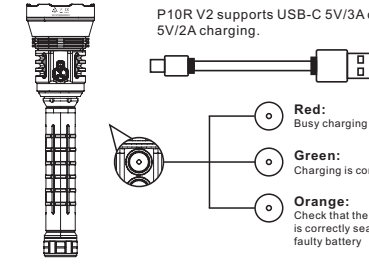

Power Indication

When the flashlight is turned ON, the LED indicator will automatically monitor the power constantly and display as follow: Green: 100%-70%; Orange: 70%-30%; Red: 30%-10%; Red Flash: 10%-1% (The red LED will keep flashing to remind the power if running out soon.)

Usage and Maintenance

- Please fully charge the battery before initial use.
To maintain the waterproof rating, please lubricate the O-ring with silicone safe lubricant and replace broken O-rings as soon as possible.
If the light will not be used for a long period or when transported, please unscrew the tail cap and remove the battery to break the circuit.

Warranty

- The product is provided with a 5-year warranty. Any non-artificial damage, please contact the SPERAS after-sales department.
The warranty does not cover normal wear and tear, modifications, misuse, disintegrations, negligence, accidents, improper maintenance or repairs by anyone other than an authorized retailer or SPERAS itself.

Beyond Warranty

Free warranty DO NOT cover any damage or failure caused by: Normal wear up; Damages caused by disassembling, modifying the flashlight; Damages caused by rough operation or misuse; Improper maintenance or repairs by anyone other than an authorized retailer or SPERAS itself.

Shenzhen Speras Lighting Co., Ltd
Add: 4F, Building G, Gangshen Innovation Park, Huangning Road, Dalang Street, Longhua District, Shenzhen, China. 518109
Tel: +86-755-2107 2597
Email: info@speraslight.com
Website: www.speraslight.com

SPERAS Warranty Card

Product Model No.: _____
Serial No.: _____
Date of Purchase: _____
Dealer Signature / Stamp: _____

Thank you for choosing SPERAS. The SPERAS flashlight is covered by a 5-year warranty from the date of purchase. Please ask the dealer/distributor to fulfill the date of purchase and sign/stamp the warranty card after purchase. Contact the dealer/distributor of SPERAS first if help needed.
Notice: The warranty covers manufacturer defects solely and becomes invalid if the flashlight is subjected to work by an unauthorized party.

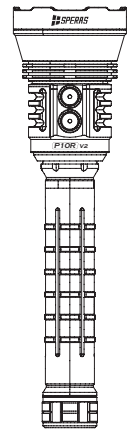

P10R V2 说明书

危险提示

- 首次使用, 请详细阅读说明书。
请勿将光线直射眼睛, 这可能会导致暂时失明或对眼睛造成永久性损伤。
请勿在手电筒开启时遮盖灯头, 或将灯头放在地上。光的热扩散可能会导致手电筒本身的损坏, 甚至导致其他物体燃烧。
放在儿童接触不到的地方。
请勿在高温下反复开启极亮模式, 以防止手电筒过热烫伤手。
请使用配套电池。

包装包含

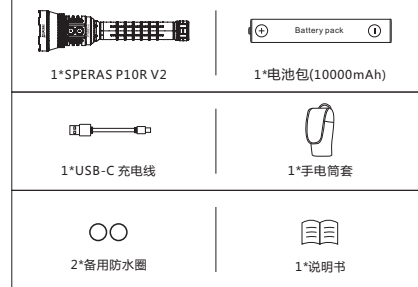

产品参数

Table with columns: ANSIL标准参数, 极亮, 高亮, 中亮, 低亮, 极低亮, 爆闪, SOS. Rows include Output, Beam, Light, Range, Lamp, Lens, Battery, Charge time, Protection, Water level, Material, Surface treatment, Dimension, Net weight.

产品简介

SPERAS P10R V2是一款高性能、大流明手电筒, 搭载3颗进口朗明纳斯SST70灯珠, 最大流明可达10000流明。双开光设计, 可快速换挡以及一键高亮。配置21700 10000毫安锂电池, 可支持手电稳定输出1000流明达36个小时。P10R V2是一款理想的搜索、救助、巡逻或者户外类型手电筒。使用锁定功能, 用户不用担心手电筒会在口袋或者包里意外使用。

电池安装

首次使用, 需要打开手电筒, 取出绝缘片, 再次开光, 即可使用。更换电池, 请注意按照正确的电池方向装入。

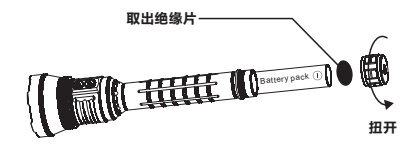

使用说明

- 上按键: 1.) 快速双击上按键可进入爆闪; 再次双击可进入SOS档位; 单击可返回爆闪之前的状态。
2.) 换挡: 在开机状态下, 单击下按键可快速换挡(极低档, 低档, 中档, 高档, 极亮档循环)。
3.) 极低亮: 在关闭状态下, 长按0.3秒下按键可进入极低亮档位。
下按键: 1.) 开关: 在关闭状态下, 单击下按键可进入记忆档位; 再长按0.3秒关闭手电筒。
2.) 换挡: 在开机状态下, 单击下按键可快速换挡(极低档, 低档, 中档, 高档, 极亮档循环)。
3.) 极低亮: 在关闭状态下, 长按0.3秒下按键可进入极低亮档位。
锁定与解锁功能: 1.) 锁定: 在任何状态下, 同时长按两个按键2秒钟, 手电筒主灯就会闪烁2次, 提示手电筒已经进入锁定状态。在锁定状态下, 触动任何按键, 橙色指示灯会闪烁2秒以提示手电筒处于锁定状态。
2.) 解锁: 快速三击任何按键, 手电筒主灯会闪烁两次提示手电筒已经解锁。

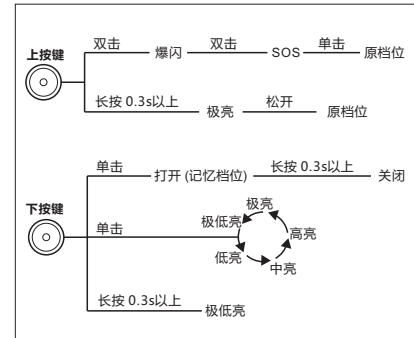

如何充电

P10R V2支持5V/3A充电和5V/2A充电, 需要使用对应的适配器。使用标配充电线, 连接上适配器, 可进行充电。充电过程中, 指示灯指示如下: 绿灯: 充电已满; 红灯: 充电中; 橙灯: 充电有问题, 需检查。提示: 仅支持使用标配电池进行充电。充电过程中, 请不要使用手电筒。

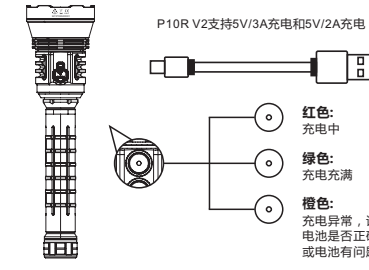

电量提示

开机后侧边指示灯会自动指示电量5秒: 指示电量如下: 绿灯: 100%-70%; 橙灯: 70%-30%; 红灯: 30%-10%; 红闪: 10%-1% (长闪提示)

使用与维护

- 手电在使用过程中, 手电表面温度在70度以下属于正常情况, 请放心使用。
首次使用前请将电池充满电。
每半年用棉签清理手电筒开关上润滑油。
为达到最佳防水性能, 请定期检查防水O圈的完整性, 并请适量涂抹润滑油于防水O圈上以延长其使用寿命。如O圈损坏, 请及时更换原厂O圈以确保您所使用之产品的优异防水性能。
长时间不使用手电筒时, 请将电池取出, 并妥善存放于阴凉干燥处。

保修条款

- 30天包换期: 本产品自售出之日起30天内, 在正常使用情况下, 出现产品质量问题, 客户可选择维修或更换同型号规格的新品。如同型号规格的产品停产或因其他原因不能在合理时间内安排更换, 则调换不低于原产品性能的同品牌产品。
5年免费保修期: 本产品自售出之日起5年内, 用户在正常使用情况下, 出现产品质量问题, 则享受免费维修服务。因使用不当或擅自改装、维修而引起的产品故障、损坏, 不在保修范围内。
终身质保服务: 在超过5年免费保修时间外, SPERAS将提供有偿维修服务, 费用以实际更换材料费用为准, 不收取人工费用。
请先联系您的经销商, 提供您购买SPERAS保修卡、购买发票、收据或其卖家的证明, 直接联系您的经销商进行售后服务, SPERAS将为经销商提供技术支持。

不在保修范围

- 免费保修不包括由以下原因引起的任何损坏或故障: 正常使用磨损; 因拆卸、改装手电筒而造成的损坏; 因暴力操作或使用不当造成的损坏; 除经授权的零售商SPERAS本身以外的任何人进行的不当维护或修理。

深圳市思贝照明有限公司
地址: 深圳市龙华新区大浪街道华宁路
港深创新园G栋420-424
电话: +86-755-2107-2597
网址: www.speraslight.com
邮箱: info@speraslight.com

SPERAS 保修卡

产品型号: _____
产品序列号: _____
购买日期: _____
经销商签名/盖章: _____

感谢您选择 SPERAS. SPERAS 手电筒自购买之日起享有 5 年保修。购买后请要求经销商填写购买日期并在保修卡上签字/盖章。如果需要帮助, 请先联系 SPERAS 手电筒的经销商。

注意: 保修条款仅涵盖制造商缺陷。

双面印刷 折后尺寸60x90mm